



2 – 12"



Option Available on
2 ½ – 6" Units

1.0 PRODUCT DESCRIPTION

Available Sizes

- 2 – 12"/DN50 – DN300

Maximum Working Pressure

- 300 psi/2068 kPa/21 bar

Operating Temperature

- Dependent on gasket selection from section 3.0

Application

- Provides straight-through flow for lower pressure drops

NOTES

- Factory-installed blow down drain valve available upon request only in sizes 2 ½"/73.0 mm, 3"/DN80, 4"/DN100 and 6"/DN150.
- For information on the Series W732 AGS Wye Type Vic-Strainer, see [publication 20.19](#).

2.0 CERTIFICATION/LISTINGS

Not applicable – contact Victaulic with any questions.

ALWAYS REFER TO ANY NOTIFICATIONS AT THE END OF THIS DOCUMENT REGARDING PRODUCT INSTALLATION, MAINTENANCE OR SUPPORT.

System No.		Location	
Submitted By		Date	

Spec Section		Paragraph	
Approved		Date	

3.0 SPECIFICATIONS – MATERIAL

Housing (Body, Coupling, End Cap): Ductile iron conforming to ASTM A536, Grade 65-45-12.

Housing Coating: (specify choice)

Standard: Orange enamel

Optional: Hot dipped galvanized

Optional: Fusion bonded epoxy (Max. operating temperature +140°F/+60°C)

Basket: Stainless steel, Type 304.

Standard: Perforated metal.

2 – 3"/DN50 – DN80: 0.062"/1.6 mm diameter perforations on 0.09"/2.3 mm centers, 41% open area.

4 – 12"/DN100 – DN300: 0.125"/3.2 mm diameter perforations on 0.19"/4.8 mm centers, 40% open area.

Other perforation sizes and open areas are available. Please contact Victaulic for details.

Optional: Mesh Underlay: Perforated metal with woven wire underlay.

2 – 6"/DN50 – DN150: 0.156"/3.97 mm diameter perforations on 0.188"/4.6 mm centers, 63% open area.

Underlaid with wire mesh with greater than 45% open area.

8 – 12"/DN200 – DN300: 0.188"/4.76 mm diameter perforations on 0.25"/6.35 mm centers, 51% open area.

Underlaid with wire mesh with greater than 45% open area.

NOTE

- Mesh underlay available with minimum opening size of 0.025"/0.64 mm. Contact Victaulic for details.

Gasket: (specify choice¹)

Victaulic EPDM

(Green color code). Temperature range –30°F to +230°F/–34°C to +110°C. NOT RECOMMENDED FOR PETROLEUM SERVICES.

Victaulic Nitrile

(Orange color code). Temperature range –20°F to +180°F/–29°C to +82°C. Not compatible for hot water services over +150°F/+66°C or for hot dry air over +140°F/60°C. NOT RECOMMENDED FOR HOT WATER SERVICES.

¹ Supplemental lubricant is recommended for services installed at or continuously operating below 0°F/-18°C.

Bolts/Nuts: Heat-treated plated carbon steel zinc-electroplated to ASTM B633, track head conforming to physical properties of ASTM A183, minimum tensile 110,000 psi/758340 kPa.

Couplings: Supplied with (1) Victaulic Style 07 Zero-Flex® coupling for cleaning access.

Blow Down Port: NPT tap provided in the cap for a discharge valve connection, allowing solids to be “blown down” while the system is in service. Strainer supplied with cap plugged.

Blow Down Drain Valve: DZR brass. Available upon request only in sizes 2½"/73.0 mm, 3"/DN80, 4"/DN100 and 6"/DN150.

4.0 DIMENSIONS

Series 732 Wye-Type Vic-Strainer

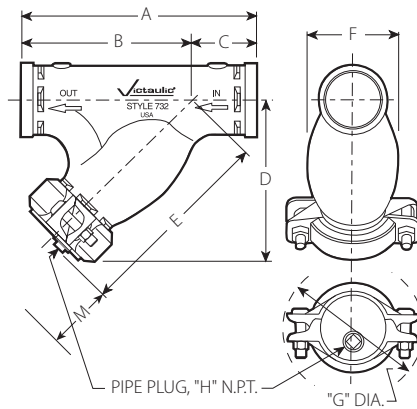

Size		Dimensions											Weight
Nominal inches DN	Actual Outside Diameter inches mm	End to End A inches mm	B inches mm	C inches mm	D inches mm	D1 inches mm	E inches mm	E1 inches mm	F inches mm	G ² inches mm	H inches mm	M ³ inches mm	Approximate (Each) lb kg
2 DN50	2.375 60.3	9.75 248	7.00 178	2.75 70	7.54 192	– –	8.54 217	– –	3.31 84	5.78 146	0.50 13	6.25 158	10.0 4.5
2 ½	2.875 73.0	10.75 273	7.75 197	3.00 76	8.32 211	9.75 248	9.32 237	11.60 295	3.94 100	6.38 162	0.50 13	7.00 177	14.0 6.4
DN65	3.000 76.1	10.75 273	7.75 197	3.00 76	8.32 211	– –	9.32 237	– –	3.94 100	6.61 167	0.50 13	7.00 177	14.0 6.4
3 DN80	3.500 88.9	11.75 299	8.50 216	3.25 83	9.08 231	10.40 264	10.14 258	12.15 309	4.64 117	6.81 173	0.75 19	7.83 198	20.0 9.1
4 DN100	4.500 114.3	14.25 362	10.50 267	3.75 95	11.06 281	12.22 310	12.36 314	14.32 364	6.19 157	8.21 208	1.00 25	9.70 246	32.0 14.5
5	5.563 141.3	16.50 419	12.50 318	4.00 102	13.00 330	– –	14.36 365	– –	7.73 196	9.89 251	1.00 25	12.00 304	50.0 22.7
DN125	5.500 139.7	16.50 419	12.50 318	4.00 102	13.00 330	– –	14.36 365	– –	7.73 196	9.89 251	1.00 25	12.00 304	50.0 22.7
6 DN150	6.625 168.3	18.50 470	14.00 356	4.50 114	14.44 367	15.50 394	16.06 408	17.95 456	9.12 231	10.83 275	1.25 32	13.38 339	72.0 32.7
	6.500 165.1	18.50 470	14.00 356	4.50 114	14.44 367	– –	16.06 408	– –	9.12 231	10.83 275	1.25 32	13.38 339	72.0 32.7
8 DN200	8.625 219.1	24.00 610	18.00 457	6.00 152	18.38 467	– –	20.50 521	– –	12.24 310	13.74 349	1.50 38	17.44 443	125.0 56.7
10 DN250	10.750 273.0	27.00 686	21.00 533	6.00 152	22.00 559	– –	23.82 605	– –	14.02 356	16.98 431	2.00 51	20.75 527	205.0 93.0
12 DN300	12.750 323.9	30.00 762	24.50 622	5.50 140	24.75 629	– –	27.37 695	– –	16.89 429	18.88 479	2.00 51	24.50 622	280.0 127.0

² Dimensions will vary depending upon coupling orientation.

³ Dimension "M" represents minimum clearance required to remove the basket from the strainer.

5.0 PERFORMANCE

Series 732 Wye-Type Vic-Strainer

Size		Maximum Working Pressure ⁴
Nominal inches DN	Actual Outside Diameter inches mm	
2 DN50	2.375 60.3	300 2065
2 ½	2.875 73.0	300 2065
DN65	3.000 76.1	300 2065
3 DN80	3.500 88.9	300 2065
4 DN100	4.500 114.3	300 2065
5	5.563 141.3	300 2065
DN125	5.500 139.7	300 2065
6 DN150	6.625 168.3	300 2065
	6.500 165.1	300 2065
8 DN200	8.625 219.1	300 2065
10 DN250	10.750 273.0	300 2065
12 DN300	12.750 323.9	300 2065

⁴ Working pressure is maximum and will be governed by couplings used for installation and related system components. Maximum differential pressure from inlet to outlet must not exceed 10 psi/69 kPa.

5.1 PERFORMANCE

Series 732 Wye-Type Vic-Strainer

Flow Rate

Cv/Kv values for flow of water at +60°F/+16°C are shown in tables below.

Formulas for Cv/Kv values:

$$\Delta P = \frac{Q^2}{C_v^2}$$

$$Q = C_v \times \sqrt{\Delta P}$$

Where:

Q = Flow (GPM)

ΔP = Pressure Drop (psi)

C_v = Flow Coefficient

$$\Delta P = \frac{Q^2}{K_v^2}$$

$$Q = K_v \times \sqrt{\Delta P}$$

Where:

Q = Flow (m³/hr)

ΔP = Pressure Drop (Bar)

K_v = Flow Coefficient

Size		Full Open C _v K _v
Nominal inches DN	Actual Outside Diameter inches mm	
2 DN50	2.375 60.3	72 62
2½ DN65	2.875 73.0	111 96
	3.000 76.1	111 96
3 DN80	3.500 88.9	164 142
	4 DN100	4.500 114.3
5 DN125		5.563 141.3
	6 DN150	5.500 139.7
8 DN200		6.625 168.3
	10 DN250	6.500 165.1
12 DN300		8.625 219.1
		10.750 273.0
		12.750 323.9

NOTE

- Data listed above applies to Series 732 Wye-Type Vic-Strainers with either standard or mesh underlaid baskets.

5.2 PERFORMANCE

Series 732 Wye-Type Vic-Strainer

Flow Characteristics

The charts below express the flow of water at 65°F/18°C.

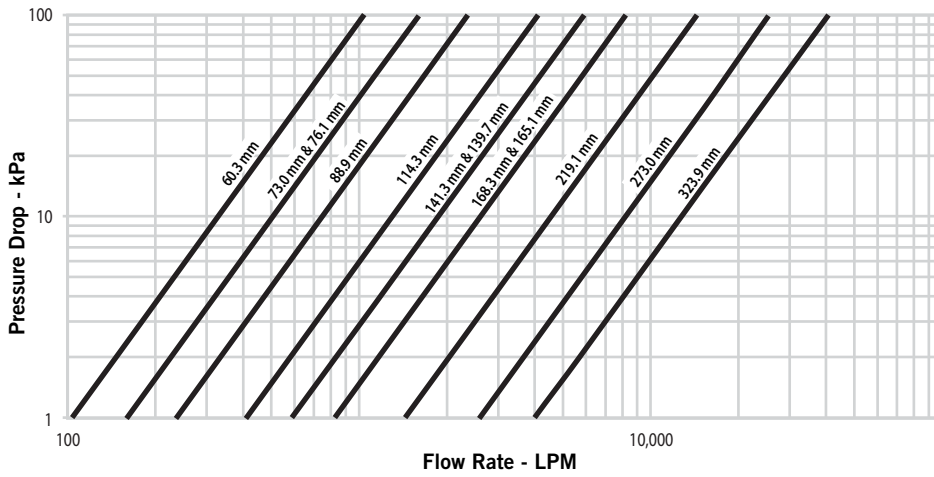
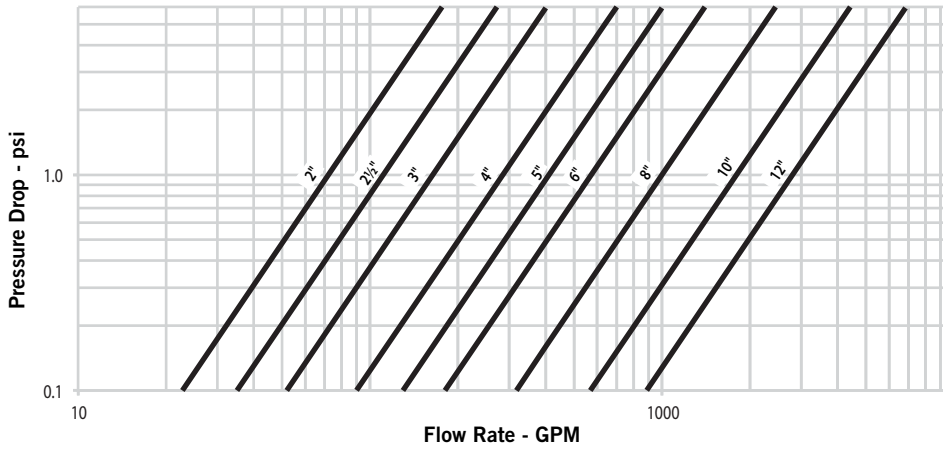







NOTE

- Data listed above applies to Series 732 Wye-Type Vic-Strainers with either standard or mesh underlaid baskets.

6.0 NOTIFICATIONS

 **WARNING**



- Read and understand all instructions before attempting to install, remove, adjust, or maintain any Victaulic piping products.
- Always verify that the piping system has been completely depressurized and drained immediately prior to installation, removal, adjustment, or maintenance of any Victaulic products.
- Wear safety glasses, hardhat, and foot protection.

Failure to follow these instructions could result in death or serious personal injury and property damage.

7.0 REFERENCE MATERIALS

- [05.01: Victaulic Seal Selection Guide](#)
- [24.01: Victaulic Pipe Preparation Tools](#)
- [I-100: Victaulic Field Installation Handbook](#)

User Responsibility for Product Selection and Suitability

Each user bears final responsibility for making a determination as to the suitability of Victaulic products for a particular end-use application, in accordance with industry standards and project specifications, and the applicable building codes and related regulations as well as Victaulic performance, maintenance, safety, and warning instructions. Nothing in this or any other document, nor any verbal recommendation, advice, or opinion from any Victaulic employee, shall be deemed to alter, vary, supersede, or waive any provision of Victaulic Company's standard conditions of sale, installation guide, or this disclaimer.

Intellectual Property Rights

No statement contained herein concerning a possible or suggested use of any material, product, service, or design is intended, or should be construed, to grant any license under any patent or other intellectual property right of Victaulic or any of its subsidiaries or affiliates covering such use or design, or as a recommendation for the use of such material, product, service, or design in the infringement of any patent or other intellectual property right. The terms "Patented" or "Patent Pending" refer to design or utility patents or patent applications for articles and/or methods of use in the United States and/or other countries.

Note

This product shall be manufactured by Victaulic or to Victaulic specifications. All products to be installed in accordance with current Victaulic installation/assembly instructions. Victaulic reserves the right to change product specifications, designs and standard equipment without notice and without incurring obligations.

Installation

Reference should always be made to the Victaulic installation handbook or installation instructions of the product you are installing. Handbooks are included with each shipment of Victaulic products, providing complete installation and assembly data, and are available in PDF format on our website at www.victaulic.com.

Warranty

Refer to the Warranty section of the current Price List or contact Victaulic for details.

Trademarks

Victaulic and all other Victaulic marks are the trademarks or registered trademarks of Victaulic Company, and/or its affiliated entities, in the U.S. and/or other countries.